

Ø560

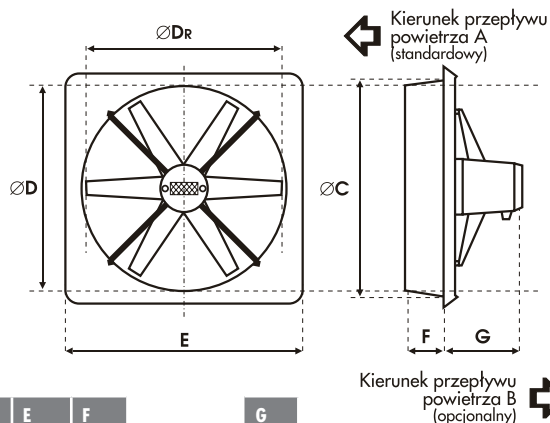

	D _R mm	D mm	C mm	E mm	F mm	G mm
0560	555	560	570	715	100	0,25 kW 220
						0,37 kW 220
						0,55 kW 230

TYP WENTYLATORA	PRĘDKOŚĆ OBROTOWA (min ⁻¹)	WYDAJNOŚĆ (m ³ h)	MOC (kW)	PRĄD (A)	IP	MAX. TEMP. PRACY (°C)	MASA (kg)	CIŚNIENIE AKUSTYCZNE SPL dB(A)	MOC AKUSTYCZNA Lw dB(A)	TYP REGULATORA
1 560/R/3-6/40/230	1350	8850	0,25	1,8	66	60	12	64	75	SPA-3
2 560/R/6-6/40/230	1350	9830	0,37	2,8	66	60	13	66	77	SPA-3
3 560/R/6-6/35/400	1400	8880	0,37	1,2	66	60	13	64	75	FT-1,2 / FJ-3,5
4 560/R/6-6/45/230	1350	11400	0,55	4,0	66	60	15	70	81	SPA-5
5 560/R/6-6/45/400	1400	11900	0,55	1,3	66	60	15	70	81	FT-2,1 / FJ-3,5
6 560/R/8-8/40/230	1350	10800	0,55	4,0	66	60	16	68	79	SPA-5
7 560/R/8-8/35/400	1400	9960	0,55	1,3	66	60	16	67	78	FT-2,1 / FJ-3,5

Informacje na temat metod pomiaru parametrów podanych w tabeli i wykresach znajdują się na pierwszej stronie katalogu

CHARAKTERYSTYKI WENTYLATORÓW

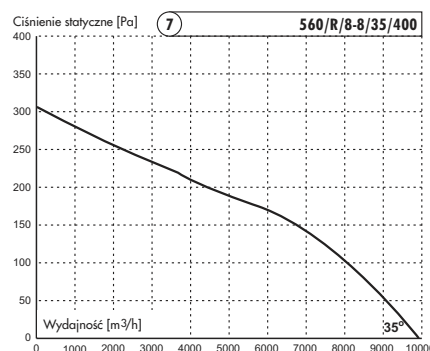
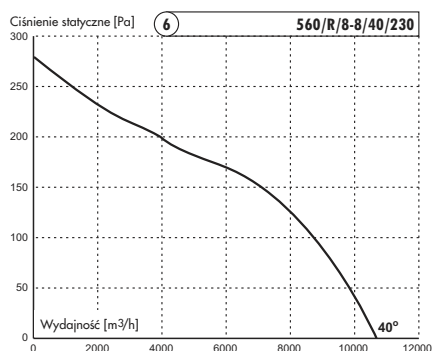
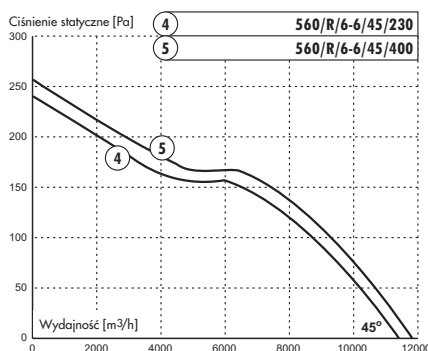
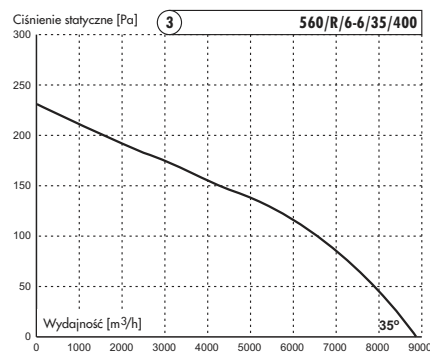
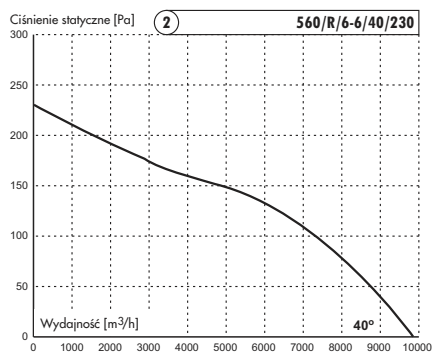
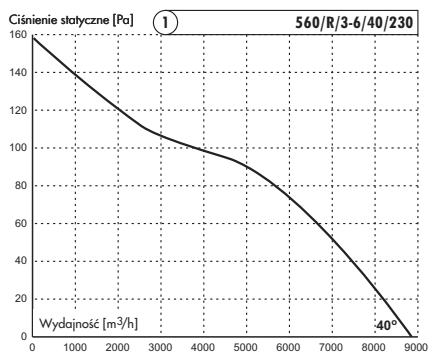

ZAWEX.PL

- FALOWNIKI - WENTYLATORY - ODPYLACZE -



LS Industrial Systems

New name of  LG Industrial Systems

P.H.U. ZAWEX, KRASNE 830A

k/RZESZOWA, 36-007 KRASNE

Tel: 601478570, Tel/Fax. (017) 8555744

www.zawex.pl, e-mai: zawex@zawex.pl